

eQ Lateral

eQ Stauraum – Einfache Steckverbindungen erlauben die flexible Organisation des eQ Lateralsschranks. Mit Hängeregisterschubladen, Hängeregisterauszügen, Tablaren und in sich frei organisierbaren Breitschubladen sind der optimalen Raumnutzung fast keine Grenzen gesetzt.

E SEIT 1904
SCHWEIZER
MÖBELHERSTELLER



Standardausführung

Masse	Breite	80 cm / 120 cm
	Höhe	78 cm / 116 cm
	Tiefe	40.4 cm
Materialisierung	Vollblech pulverbeschichtet, Innenseiten immer grau	
Farben	pulverbeschichtet gemäss Kollektion	
Typ	Gleiter oder Rollen	
Standrohr und Griffe	Pulverbeschichtet, Aluminium matt eloxiert oder glanzverchromt	
Rollladen	Alu metallisé silber B3, Lichtgrau RAL 7035, Tiefschwarz RAL 9005 oder Verkehrsweiss RAL 9016	
Schliessung	Schlossattrappe, Lehmann Zylinder oder First Zylinder	



Vermassungen

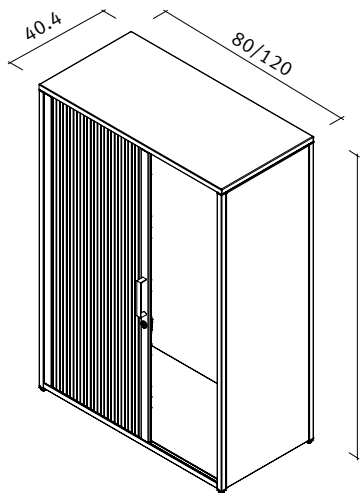

eQ Lateralschrank 3H

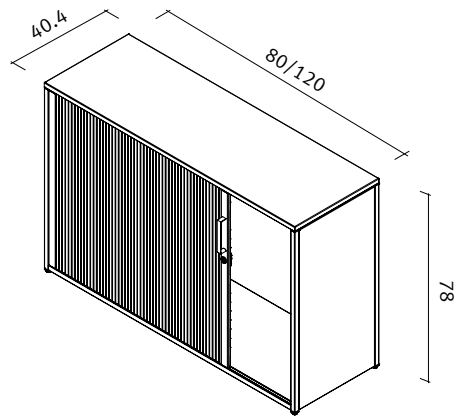

eQ Lateralschrank 2H

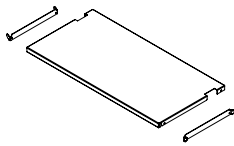

Tablar

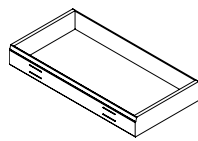

Hängeregister-Auszug

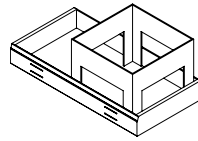

Hängeregister-Schublade

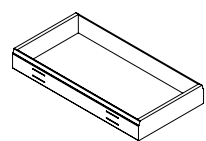

Breitschublade

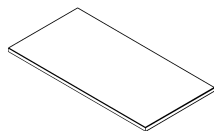

Abschlussplatte

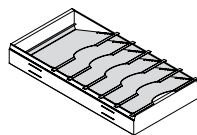

Schrägfacheinsatz

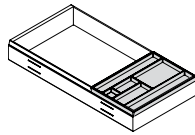

Materialschale

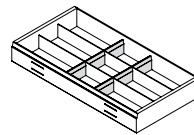

Quertrennplatte

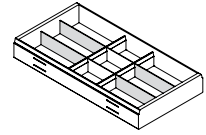

Steckplatte

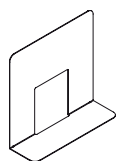

Ordnerstütze





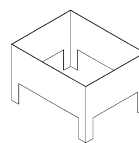











Ordnerstütze



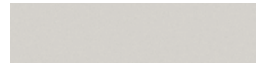



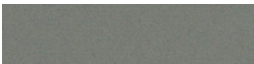

Hängeregister-Korb

eQ Oberflächen Module und Tischgestelle

Seidenglanzfarben

				
Verkehrsweiss* RAL 9016	Weissgrün NCS 1015 G80Y	Lichtblau NCS 2010 R80B	Enzianblau RAL 5010	Stahlblau RAL 5011
				
Karminrot RAL 3002	Rotorange RAL 2001	Goldgelb RAL 1004	Gelbgrün RAL 6018	Lichtgrau RAL 7035
				
Staubgrau RAL 7037	Graubraun RAL 8019	Tiefschwarz* RAL 9005	Anthrazit metallisé* B1	Schwarz metallisé B2
		* Säulenfarben für höhenverstellbare Tische		
Alu metallisé silber* B3	Grau metallisé GM			

Matte Softtouchfarben

				
Samtweiss Trend 8	Sandbeige Design 12	Polarblau Design 17	Lavarot Design 15	Goldkastanie Style 26
				
Quarzgrau Classic 37	Basaltschwarz Trend 9			

Seitenprofile, Griffe und Fussausleger

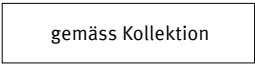
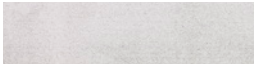
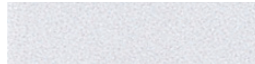
			* ausgenommen Airdesk
Pulverbeschichtet	Alu matt / mattverchromt*	Glanzverchromt*	