

# Caisson et Caddy eQ

Caissons pour postes de travail fixes ou caddies pour le choix libre du poste de travail. De construction identique en tôle d'acier, ils sont dotés de la fonctionnalité adéquate et complètent le système modulaire.

**E** DEPUIS 1904  
FABRICANT  
DE MEUBLES SUISSE



**embru**

meubles pour toute une vie

## Exécution standard

### Caddy

dimensions	40 × 40 × 110 cm (L × P × H)
version de base	intérieur sans compartimentage, pièces intérieures toujours de couleur alu métallisé argent B3, portes avec compartimentage panneau terminal en bois laqué selon RAL/NCS, poignée sans boîte aux lettres profils revêtus par poudre selon collection serrure Lehmann 4 roulettes pivotantes
classification standard	1 étagère 1 tiroir 6.5 cm, y c. bac de matériel 1 étagère 1 tiroir pour dossiers suspendus

### Caisson

dimensions	43 × 60 × 57 cm (L × P × H) 43 × 80 × 57 cm (L × P × H)
matériaux	tôle pleine revêtue par poudre selon collection
équipement	tube vertical et poignées au choix avec poignée en forme d'étrier ou barre de préhension revêtement par poudre, aluminium anodisé mat ou chromé brillant patins ou roulettes serrure factice, cylindre Lehmann ou cylindre First

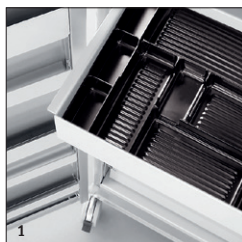

### Propriétés

- 1 Intérieur variable du Caddy avec tiroir à matériel
- 2 Poignée à tirer
- 3 Roulettes pivotantes
- 4 Roulettes pivotantes chromé brillant
- 5 Tiroir pour dossiers suspendus au choix avec panier, tôle d'enveloppe avec ou sans traverse
- 6 Caisson avec poignée
- 7 Serrure

## Mesures

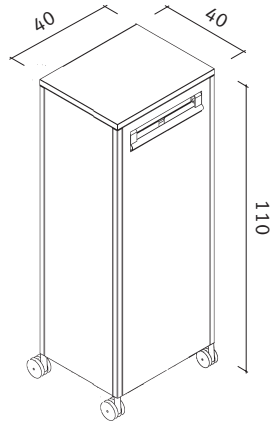

eQ Caddy

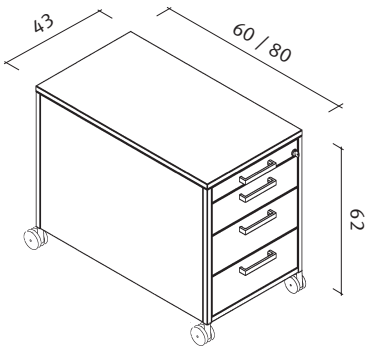

Caisson eQ 9666

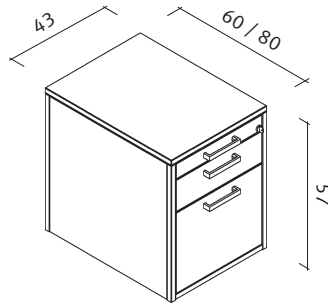

Caisson eQ 964

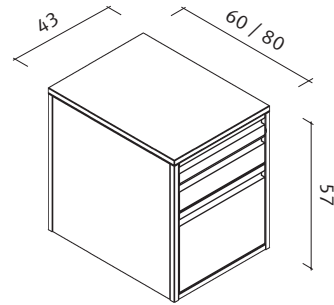

Caisson eQ avec poignée profil

## Organisation caddy

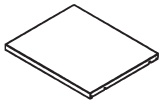

Etagère

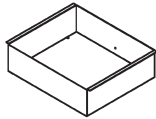

Tiroir

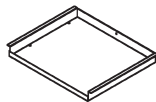

Bac à matériel accrochable

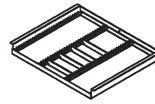

Bac à matériel avec compartiments



Bac à matériel

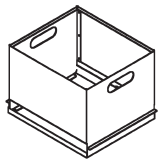

Panier pour dossiers suspendus

## Organisation caisson profondeur 60 et 80 cm

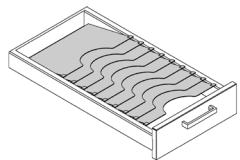

Inserts inclinés

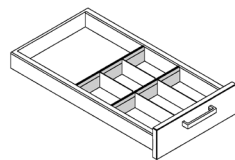

Séparateur transversal

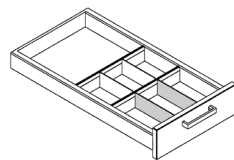

Séparateur emboîtable A5

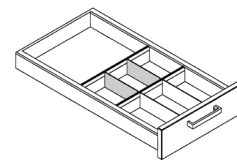

Séparateur emboîtable A6

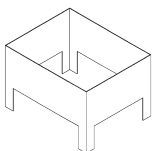



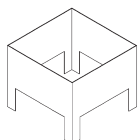







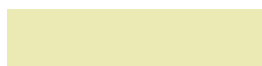





Panier pour dossiers suspendus pour caisson de 60 cm de profondeur







Panier pour dossiers suspendus pour caisson de 80 cm de profondeur

## Surfaces modules eQ et chassis de table

### Couleurs satinées

				
Blanc signalisation* RAL 9016	Vert blanc NCS 1015 G80Y	Bleu clair NCS 2010 R80B	Bleu gentiane RAL 5010	Bleu acier RAL 5011
				
Rouge carmin RAL 3002	Orangé rouge RAL 2001	Jaune or RAL 1004	Vert jaune RAL 6018	Gris clair RAL 7035
				
Gris poussière RAL 7037	Brun gris RAL 8019	Noir foncé* RAL 9005	Anthracite métallisé* B1	Noir métallisé B2
		* Couleurs des colonnes Lift Table II		
Alu métallisé Argent* B3	Gris métallisé GM	* Couleurs des colonnes Lift Table II		

### Couleurs mates softtouch

				
Blanc velours Trend 8	Beige sable Design 12	Bleu polaire Design 17	Rouge lave Design 15	Châtain doré Style 26
				
Gris quartz Classic 37	Noir basalte Trend 9			

### Profils latéraux, poignées et pieds de tables

			* sauf Airdesk
Revêtement par poudre	Alu mat / chromé mat	Chromé brillant*	* sauf Airdesk